



nanoled
LIGHTING

H1 H2 H3
PROFILI CON MAGNETI

Estruso in alluminio anodizzato dalle dimensioni particolarmente ridotte, disegnato e prodotto per essere installato anche su superfici di spessore minimo. Estrema facilità di montaggio garantita dal diffusore satinato ad inserimento a scatto, dai magneti a scomparsa o dalle molle in acciaio. Ideale per ospitare e dissipare correttamente Strip LED, particolarmente indicato per illuminare ed impreziosire pensili di cucine e bagni, sotto pensili, mobili, armadi, mensole e vetrine. **PRODOTTO SEMPRE DISPONIBILE**

*Very small anodized aluminium profile, designed and produced to be installed on surfaces even with a minimum thickness. Extreme versatility and adaptability guaranteed by the wide range of accessories, like magnets or springs that allows the composition of various combinations. This profile is ideal for heat dissipation for the LED strip and can illuminate kitchens, undercabinet, furniture, cabinets and shelves. **ALWAYS READY ON OUR STOCK***

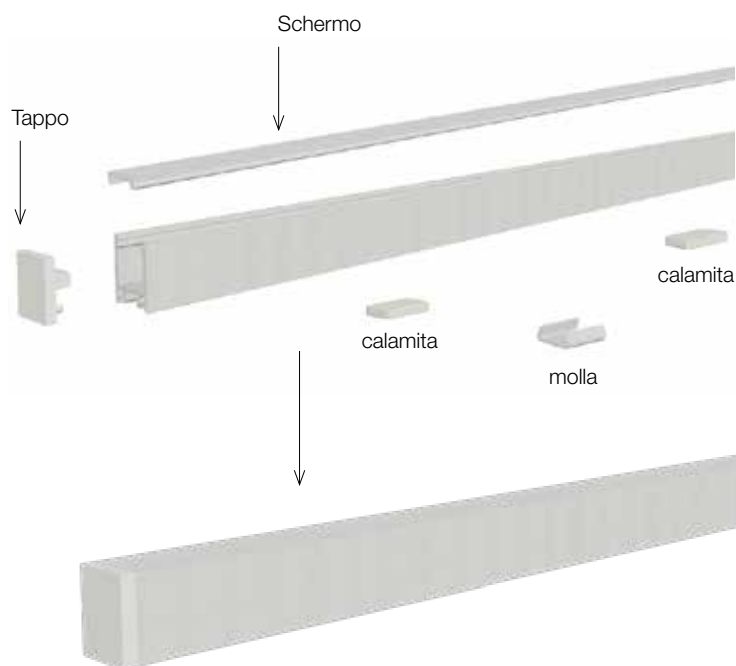

DIMENSIONI / DIMENSIONS	CODICI BASE / BASE CODES	LUNGHEZZA / LENGTH	FINITURE / FINISHINGS
SCALA 1:1	PA.H1.	1 1000 mm 2 2000 mm 3 3000 mm	<input type="checkbox"/> 1 Bianco opaco RAL9003 / Matt white RAL9003 <input checked="" type="checkbox"/> 2 Nero opaco RAL9005 / Matt black RAL9005 <input checked="" type="checkbox"/> 7 Argento anodizzato / Anodized silver

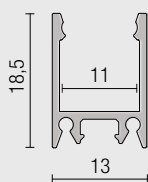

SU RICHIESTA SI EFFETTUANO TAGLI INCLINATI, FUORI MISURA E ALTRE FINITURE
 POSSIBILITY TO ORDER CUSTOM PROFILE SIZE, FINISHING AND TILTED CUTTING UPON REQUEST

Esempio di codifica: Profilo H1 + Lunghezza 1000 mm + Finitura Anodizzato argento = Codice: PA.H1.17
 Example of codification: H1 Profile + Length 1000 mm + Finishing Anodized silver = Code: PA.H1.17

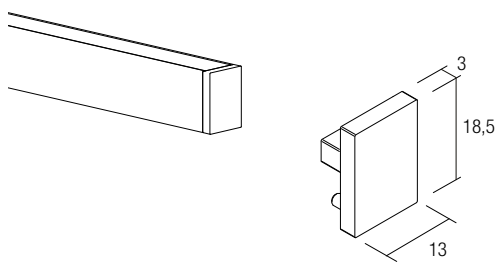

CODICI BASE / BASE CODES

FINITURE / FINISHINGS

SH1.

- 1 Bianco / White
- 2 Nero opaco / Matt black
- 7 Alluminio satinato / Satin aluminum

Tappo laterale di chiusura, realizzato in alluminio.
 Montaggio semplice e veloce mediante leggera pressione laterale.
 Side cap of closure, made of aluminum.
 Quick and easy assembly by slight lateral pressure

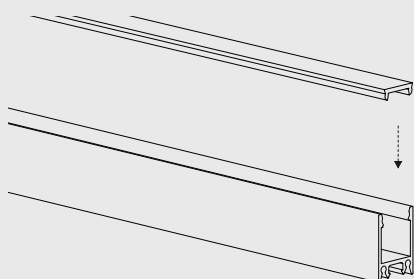

CODICI BASE / BASE CODES

PA.12PE41.1
1000mm

PA.12PE41.2
2000mm

PA.12PE41.3
3000mm

Diffusore satinato installabile a pressione.
 E' possibile rimuovere facilmente il diffusore per eventuali manutenzioni.
 Satin diffuser installed with a slight pressure.
 Easy to remove for maintenance.

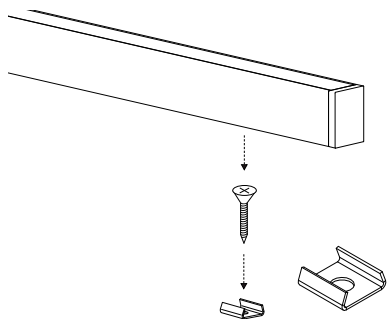

CODICI BASE / BASE CODES

PA.GG02

Clip in acciaio per fissaggio a scatto su superfici piane.
 La clip si aggancia sulle asole posteriori che risulterà perfettamente aderente alla superficie.
 Vite M2,5x12 inclusa.
 Steel clip for snap-on surfaces. The clip snaps on the rear slots of the profile that sticks perfectly to the surface. Screw M2,5x12 included.

CODICI BASE / BASE CODES

H1.MG

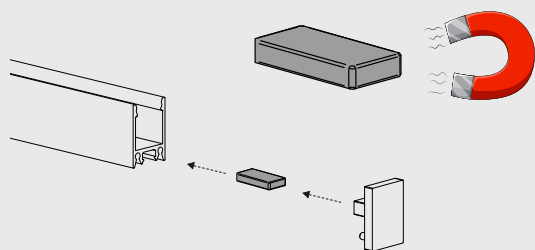

Calamita polarizzata per fissaggio su superfici ferrose.
 Facile montaggio grazie al pratico binario sul profilo in alluminio. **Set di 8 pezzi.**
 Polarized magnet for fixing on ferrous surfaces.
 Easy assembly thanks to the practical rail on the aluminum profile. **Set of 8 pieces.**

STRIP CONSIGLIATE / RECOMMENDED STRIP

S2835.xx2	17W/m	2000 lm/m	24Vdc	CRI>80
S2835.xx3	21W/m	2500 lm/m	24Vdc	CRI>80
S2835.xx2+	22W/m	2500 lm/m	24Vdc	CRI>90

Estruso in alluminio anodizzato dalle dimensioni particolarmente ridotte, disegnato e prodotto per essere installato anche su superfici di spessore minimo. Estrema facilità di montaggio garantita dal diffusore satinato ad inserimento a scatto, dai magneti a scomparsa o dalle molle in acciaio. Ideale per ospitare e dissipare correttamente Strip LED, particolarmente indicato per illuminare ed impreziosire pensili di cucine e bagni, sotto pensili, mobili, armadi, mensole e vetrine. **PRODOTTO SEMPRE DISPONIBILE**

*Very small anodized aluminium profile, designed and produced to be installed on surfaces even with a minimum thickness. Extreme versatility and adaptability guaranteed by the wide range of accessories, like magnets or springs that allows the composition of various combinations. This profile is ideal for heat dissipation for the LED strip and can illuminate kitchens, undercabinet, furniture, cabinets and shelves. **ALWAYS READY ON OUR STOCK***

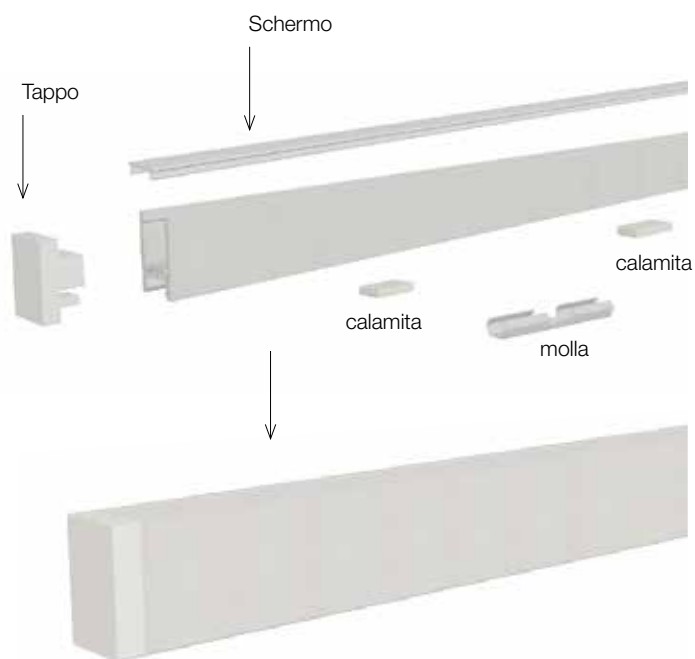

DIMENSIONI / DIMENSIONS	CODICI BASE / BASE CODES	LUNGHEZZA / LENGTH	FINITURE / FINISHINGS
-------------------------	--------------------------	--------------------	-----------------------

SCALA 1:1

PA.H2.

- 1 1000 mm
- 2 2000 mm
- 3 3000 mm

- 1 Bianco opaco RAL9003 / Matt white RAL9003
- 2 Nero opaco RAL9005 / Matt black RAL9005
- 7 Argento anodizzato / Anodized silver

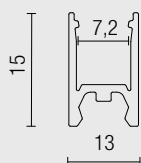

SU RICHIESTA SI EFFETTUANO TAGLI INCLINATI, FUORI MISURA E ALTRE FINITURE
 POSSIBILITY TO ORDER CUSTOM PROFILE SIZE, FINISHING AND TILTED CUTTING UPON REQUEST

Esempio di codifica: Profilo H2 + Lunghezza 1000 mm + Finitura Anodizzato argento = Codice: PA.H2.17
 Example of codification: H2 Profile + Length 1000 mm + Finishing Anodized silver = Code: PA.H2.17

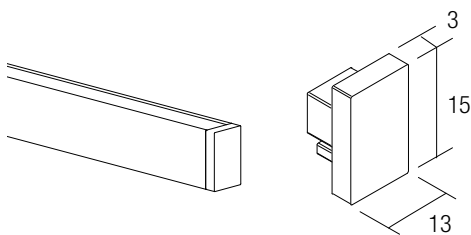

CODICI BASE / BASE CODES

FINITURE / FINISHINGS

SH2.

- 1 Bianco / White
- 2 Nero opaco / Matt black
- 7 Alluminio satinato / Satin aluminum

Tappo laterale di chiusura, realizzato in alluminio.
 Montaggio semplice e veloce mediante leggera pressione laterale.
 Side cap of closure, made of aluminum.
 Quick and easy assembly by slight lateral pressure

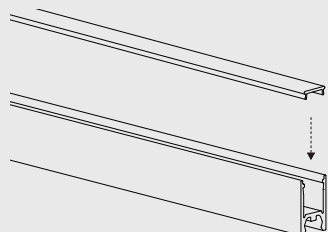

CODICI BASE / BASE CODES

PA.PL0720.1
1000mm

PA.PL0720.2
2000mm

PA.PL0720.3
3000mm

Diffusore satinato installabile a pressione.
 E' possibile rimuovere facilmente il diffusore per eventuali manutenzioni.
 Satin diffuser installed with a slight pressure.
 Easy to remove for maintenance.

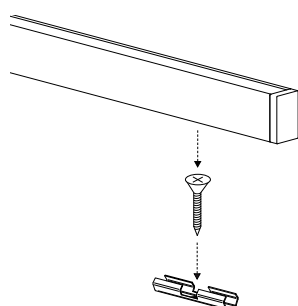

CODICI BASE / BASE CODES

PA.GG10

Clip in acciaio per fissaggio a scatto su superfici piane.
 La clip si aggancia sulle asole posteriori che risulterà perfettamente aderente alla superficie.
 Vite M2,5x12 inclusa.
 Steel clip for snap-on surfaces. The clip snaps on the rear slots of the profile that sticks perfectly to the surface. Screw M2,5x12 included.

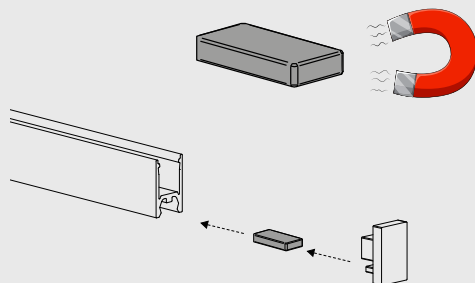

CODICI BASE / BASE CODES

H2.MG

Calamita polarizzata per fissaggio su superfici ferrose.
 Facile montaggio grazie al pratico binario sul profilo in alluminio. **Set di 8 pezzi.**
 Polarized magnet for fixing on ferrous surfaces.
 Easy assembly thanks to the practical rail on the aluminum profile. **Set of 8 pieces.**

STRIP CONSIGLIATE / RECOMMENDED STRIP

S2216.xx2 **9.6W/m** **800 lm/m** **24Vdc CRI>90**
S2216.xx4 **14.4W/m** **1050 lm/m** **24Vdc CRI>90**

Estruso in alluminio anodizzato dalle dimensioni particolarmente ridotte, disegnato e prodotto per essere installato anche su superfici di spessore minimo. Estrema facilità di montaggio garantita dal diffusore satinato ad inserimento a scatto, dai magneti a scomparsa o dalle molle in acciaio. Ideale per ospitare e dissipare correttamente Strip LED, particolarmente indicato per illuminare ed impreziosire pensili di cucine e bagni, sotto pensili, mobili, armadi, mensole e vetrine.
PRODOTTO SEMPRE DISPONIBILE

*Very small anodized aluminium profile, designed and produced to be installed on surfaces even with a minimum thickness. Extreme versatility and adaptability guaranteed by the wide range of accessories, like magnets or springs that allows the composition of various combinations. This profile is ideal for heat dissipation for the LED strip and can illuminate kitchens, undercabinet, furniture, cabinets and shelves.
ALWAYS READY ON OUR STOCK*

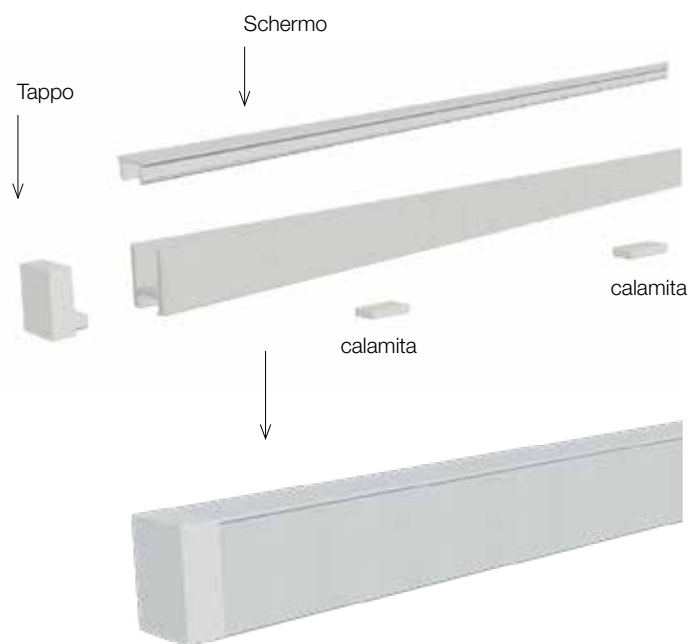

DIMENSIONI / DIMENSIONS	CODICI BASE / BASE CODES	LUNGHEZZA / LENGTH	FINITURE / FINISHINGS
SCALA 1:1	PA.H3.	1 1000 mm 2 2000 mm 3 3000 mm	<input type="checkbox"/> 1 Bianco opaco RAL9003 / Matt white RAL9003 <input checked="" type="checkbox"/> 2 Nero opaco RAL9005 / Matt black RAL9005 <input checked="" type="checkbox"/> 7 Argento anodizzato / Anodized silver

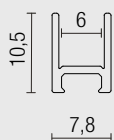

SU RICHIESTA SI EFFETTUANO TAGLI INCLINATI, FUORI MISURA E ALTRE FINITURE
 POSSIBILITY TO ORDER CUSTOM PROFILE SIZE, FINISHING AND TILTED CUTTING UPON REQUEST

Esempio di codifica: Profilo H3 + Lunghezza 1000 mm + Finitura Anodizzato argento = Codice: PA.H3.17
 Example of codification: H3 Profile + Length 1000 mm + Finishing Anodized silver = Code: PA.H3.17

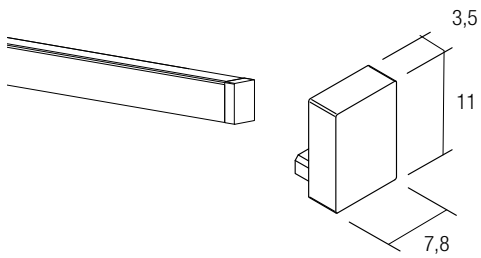

CODICI BASE / BASE CODES

FINITURE / FINISHINGS

SH3.

- 1 Bianco / White
- 2 Nero opaco / Matt black
- 7 Alluminio satinato / Satin aluminum

Tappo laterale di chiusura, realizzato in alluminio.
 Montaggio semplice e veloce mediante leggera pressione laterale.
 Side cap of closure, made of aluminum.
 Quick and easy assembly by slight lateral pressure

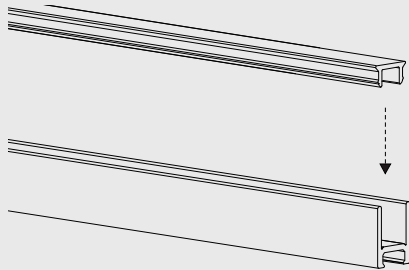

CODICI BASE / BASE CODES

PA.0006OP.1
1000mm

PA.0006OP.2
2000mm

PA.0006OP.3
3000mm

Diffusore satinato installabile a pressione.
 E' possibile rimuovere facilmente il diffusore per eventuali manutenzioni.
 Satin diffuser installed with a slight pressure.
 Easy to remove for maintenance.

CODICI BASE / BASE CODES

H3.MG

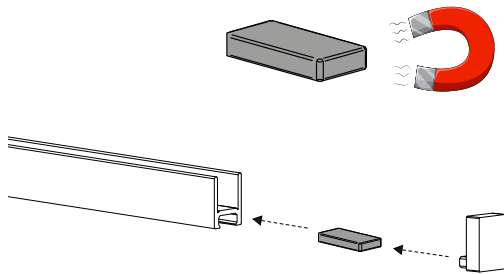

Calamita polarizzata per fissaggio su superfici ferrose.
 Facile montaggio grazie al pratico binario sul profilo in alluminio. **Set di 8 pezzi.**
 Polarized magnet for fixing on ferrous surfaces.
 Easy assembly thanks to the practical rail on the aluminum profile. **Set of 8 pieces.**

STRIP CONSIGLATE / RECOMMENDED STRIP

S2216.xx2 9.6W/m 800 lm/m 24Vdc CRI>90
S2216.xx4 14.4W/m 1050 lm/m 24Vdc CRI>90



NANOLED LIGHTING

61021 Carpegna (PU), via Pian dei Roghi, 32

Tel. + 39 0722 77418

www.nanoledlighting.com

Ufficio informazioni

info@nanoledlighting.com

MADE IN ITALY